

Basic Data

Figure 1 - Front panel and signalling (ORe1)



- 1 Operating state / Program: Green LED indicator
- 2 Operating state / Manual: Green LED indicator
- 3 Stillstand / Stop: Yellow LED indicator
- 4 Device start-up / Operation: Green LED indicator
- 5 Device failure: Red LED indicator

Figure 2 - Front panel and signalling (ORe2)



- 1 Operating state / Program: Green LED indicator
- 2 Operating state / Higher speed: Green LED indicator
- 3 Operating state / Lower speed: Green LED indicator
- 4 Stillstand / Stop: Yellow LED indicator
- 5 Device start-up / Operation: Green LED indicator
- 6 Device failure: Red LED indicator

Basic Data

Power supply:	24V AC / DC, max. 200mA
Protection Class:	II IEC 536
Degree of protection:	IP 20
Environment:	Normal Influence Class
Dimensions (WxHxD)	83 x 125 x 37 mm

Use

ORe1 controller is intended for remote (external) control of the VCB or WebClima control unit of an air-handling unit without fan output control. It is used to remotely switch on/off the air-handling device, put it into continuous operation and switch the control mode in accordance with the control unit's internal program.

ORe2 controller is intended for remote (external) control of a VCB control unit which is equipped with internal modules to control the fan output control of an air-handling unit equipped with fan output controllers. It is used to remotely switch on/off the air-handling device, put it into continuous operation in the 1. or 2. speed stage and switch the control mode in accordance with the control unit's internal program.

Technical Specification

Design

The controller's design is based on a microprocessor which is equipped with an external EEPROM memory. Its control outputs are separated by a relay. The PCB and board with connecting terminals and two jumpers is situated under the controller's cover (see figure # 3).

Operating conditions

The controller is built into a plastic casing, which enables the controller to be installed in residential as well as commercial building interiors. It can be installed in the vertical position with its rear side to the wall.

Features

Blocking the Program Function

The controller's option "Program" can be enabled or disabled using jumper J2.

J2 OFF Option "Program" disabled

J2 ON Option "Program" enabled

Setting the Switching Sequence

The transition switching sequences between the controller's operating states can be set using jumper J1.

J1 OFF Sequence order - "Up and Down"

(E.g. for ORe2: - - - - -)

J1 ON Sequence order - "Round About"

(E.g. for ORe2: - - - -)

Setting the jumper to the ON position shorts the connection; while setting the jumper to the OFF position disconnects the connection. The jumpers can be set even if the device is energized.

Automatic Restart

If a power failure occurs, after it has resumed the controller will be automatically set to the same operating state as that before the power failure.

Settings and Connection

Operating

Functions and Operating

Digital outputs of the relays, which are created by the non-voltage contacts, are controlled by the micro-processor according to the number of setting button depressions. Thus, control of the control unit, respectively air-handling unit, is ensured.

Air-Handling Unit Start-Up and Control

Spouštění a zastavení VZT jednotky, případně volba otáček nižších nebo vyšších, stejně jako volba „Program“, se provádí postupným stiskem nastavovacího tlačítka, které je vybaveno citlivým mikrospínačem. Reakce na stisk tlačítka probíhá s mírnou prodlevou (cca 1s).

LED Indicators, Operating State and Failure Signalling

The operating state of the controlled device is signalled on the controller's front panel. The operating state of the controller and controlled device is indicated by five, respectively six LED indicators:







-  **Green LED 1** is on
 - "Speed 1" indicates manual switching to lower speed,
-  **Green LED 2** is on
 - "Speed 2" indicates manual switching to higher speed,
-  **Green LED 3** is on
 - "Program" - the device is switched on/off according to the preset timing program.
-  **The yellow LED** indicator is on
 - the "STOP" state is indicated,
-  **The green LED** indicator is on
 - the "OPERATION" state of the air-handling unit is indicated,
-  **The red LED** indicator is on
 - "FAILURE" of the device is indicated.

Figure 3 - Connection of the controller



Connection of ORe1 and ORe2 Controllers to the Control Unit

■ The controller's PCB board and connecting terminals (see figure # 2) are accessible after pushing back the locking catch on the shorter side of the box and removing the box's upper cover.

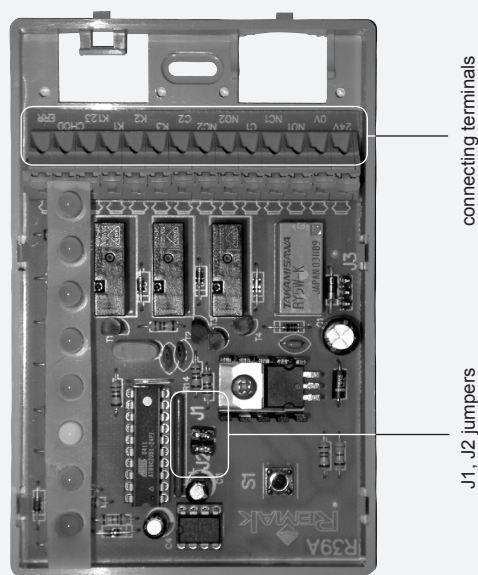
■ The connection of the controller to the VCB control unit must be performed in accordance with the wiring diagram and instructions included in the control unit's accompanying documentation (respectively the AeroCAD project).

■ The controller is connected to the control unit using an SYKFY 4x2x0,5 cable.

In the VCB control unit, the cable is connected to the "CHOD, ERR, DI7, DI8, G0 and 24V" terminals.

■ In the controller, the cable is connected to the "CHOD, ERR, Ks, K1, K2, G0 and 24V" terminals.

The controller is protected against interfering signals which could be generated while switching the power circuits in the control unit.

■ When connecting the cable, it is necessary to be very careful to avoid damaging the PCB board and terminals, as well as to observe the correct cable inter-connection between the controller and VCB control unit. Incorrect connection can cause damage or destruction of the controller.

■ The control cable must be led separately from the power cables and their concurrence must be minimized as much as possible.

■ After fixing the controller's base, connecting the cable to terminals and checking the wiring, reinstall the box's upper cover.

Safety

ORe1 and ORe2 controllers must be energized by a power supply which complies with safety rules of protection against electric shock - SELV circuit in accordance with the ČSN 33 2000-4-41 standard.

Disposal and Recycling

Controllers contain electronic parts and a plastic box. After exceeding its service life limit, the controllers belong to waste group Q14 according to the Waste Act (No.185/2001 Sb.) Regarding the possibility of parts recycling, the controllers belong to waste group R5 by course of the above-mentioned Waste Act.

Guarantee Terms and Conditions

Guarantee Terms and Conditions are provided in accordance with valid REMAK General Delivery, Payment and Guarantee Terms and Conditions. As standard, the manufacturer provides a guarantee period of 24 months from the goods delivery date. If extended guarantee conditions are fulfilled, an extended guarantee period of 5 years from the goods delivery date will be applied. The General Delivery, Payment and Guarantee Terms and Conditions are always printed on the rear side of the price list and invoice.

Basic data

Figure 1 – Front panel and signalling

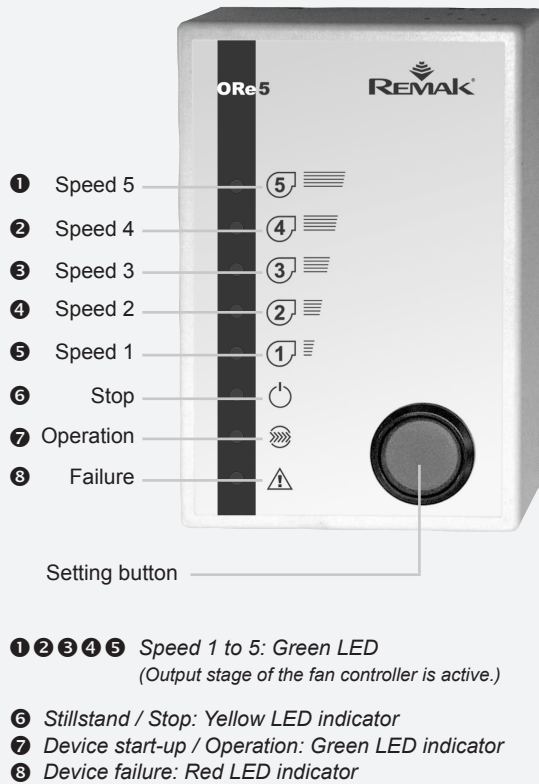

Basic data

Power supply:	24 V AC / DC, max. 80 mA
Protection Class:	II IEC 536
Degree of protection:	IP 20
Environment:	Normal Influence Class
Dimensions (WxHxD)	83 x 125 x 37 mm

Use

The ORe5 remote controller is intended for remote control of TRN controllers and XPFM frequency inverters. It serves to set the speed of fans while simultaneously signalling the operating state. If the VCB control unit is used in an air-handling assembly, the controller also serves to switch it on/off.

Technical Specification

Design

The ORe5 controller's design is based on a microprocessor which is equipped with an external serial EEPROM memory. Its control outputs are separated by a relay. This design solution enables automatic restart of the controller after a power failure.

Operating conditions

ORe5 controller is built into a plastic casing, which enables the controller to be installed in residential as well as commercial building interiors. It can be installed in the vertical position with its rear side to the wall.

Features

User Configuration Settings

The controller's PCB board, connecting terminals and J1 and J2 setting jumpers are situated under the controller's cover (see figure # 2). Setting the jumper to the ON position shorts the connection, while setting the jumper to the OFF position disconnects the connection. The jumpers can be set even if the device is energized.

Blocking of Output Stages

Jumper J2 enables blocking of the fan's switching-off to ensure a protective function - i.e. the delayed switching-off of the fan with air-handling units equipped with an electric heater and a control unit. If the „0“ speed stage is blocked, the control unit will not stop the fans until the electric heater cools down. The switching-off request from the controller is only transmitted, and the fan's speed is set to stage # 1 to cool the heater down. If the ORe5 controller is connected to a VCB control unit and an electric heater, blocking of the „0“ stage is compulsory. It is not necessary to block the „0“ stage with an air-handling assembly equipped with a water heater.

J2 OFF Without blocking the „0“ output
(without control unit, resp. with water heater)

J2 ON Blocking the „0“ output
(control unit and electric heater)

Setting the Sequence of Output Stages

The sequence of the transition from speed to speed can be set using jumper J1. If the „0“ stage is blocked, and after the selector has been switched to this position, the yellow LED indicator „STOP“ will go on, the green LED indicator „OPERATION“ will go off and the green LED indicator of Speed „1“ will stay on.

J1 OFF Speed transition sequence
(0, 1, 2, 3, 4, 5, 4, 3, 2, 1, 0,)

J1 ON Speed transition sequence
(0, 1, 2, 3, 4, 5, 0, 1, 2, 3, 4, 5,)

Figure 2 – Connection of the controller

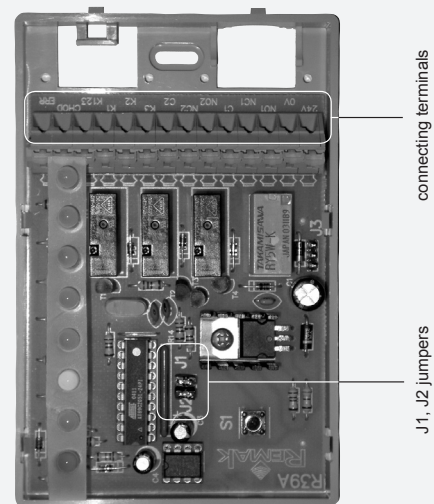

Settings and Connections

Operating

Functions and Operating

Digital outputs of the relays, which are created by the non-voltage contacts, are controlled by the micro-processor according to the number of setting button depressions. Thus, control of the control unit, respectively air-handling unit, is ensured.

Fan Start-Up and Fan Output Setting

The switching on/off of the fan, as well as the fan output (speed) setting can be performed by pressing the setting button, which is equipped with a sensitive micro-switch. The reaction to the setting button depression has a slight delay (approx. 1s) to avoid unnecessary switching of power circuits by several stages at a time while changing the output.

LED Indicators, Operating State and Failure Signalling

The operating state of the controlled device is signalled on the ORe5 controller's front panel. The operating state of the controller and controlled device is indicated by eight LED indicators.

- ① ... ⑤ Green LED 1–5 is on
- An active stage of the fan controller is indicated
- ⏻ The yellow LED indicator is on
- „STOP“ indicates the fan has stopped.
- 🌀 The green LED indicator is on
- „OPERATION“ indicates the fan is in operation
- ⚠ The red LED indicator is on
- „FAILURE“ is indicated

Automatic Restart of the Controller

The controller enables automatic restart of the fan controller after a power failure. If a power supply failure occurs, a short test of the controller's internal program will be performed after it has resumed followed by unblocking of the fan output control protection circuit. Then, the last active output is set.

Connecting to TRN Controllers

- The connection of the ORe5 controller to the TRN controllers is shown in figure # 3.
 - The connection of the controller to the TRN controllers is included in the control unit's documentation.
 - One ORe5 controller can simultaneously control as many as five TRN speed controllers.
 - The ORe5 controller's PCB board and connecting terminals (see figure # 2) are accessible after pushing back the locking catch on the shorter side of the box and removing the box's upper cover.
- The ORe5 controller is connected to the speed controller using an SYKFY 4x2x0,5 shielded cable.
- If only one TRN controller is connected, terminals 41 to 43 are connected to the ORe5 controller's terminals K1 to K3. Unblocking 46 to 49 terminals are connected to the N01, C1, NC1, Ks, 0V and 24V terminals.
 - If two or more (max. 5) TRN controllers are connected, the TRN controller's terminals 41 to 43 are

Figure 3 – Connection of the controller

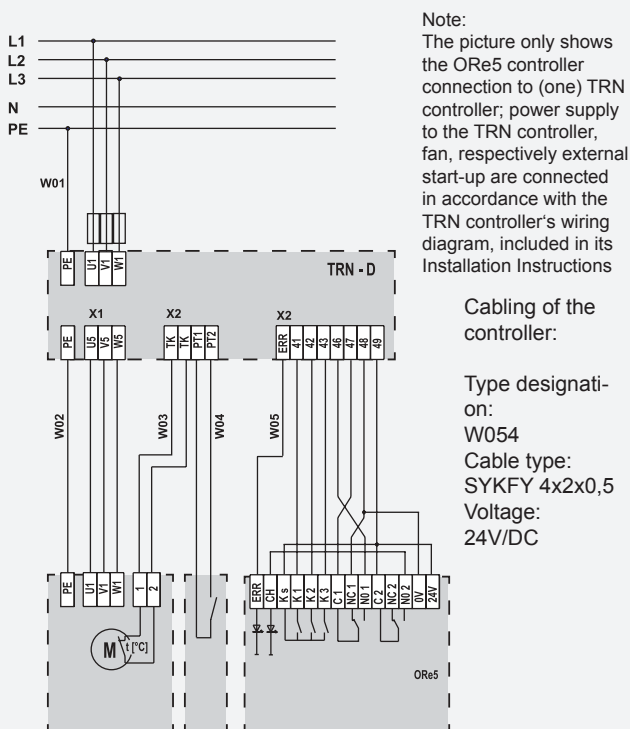

connected to the ORe5 controller's terminals K1, K2 and K3 while unblocking terminals 46 to 48 of all TRN controllers are connected in series to the ORe5 controller's terminals N01, C1, NC1, Ks and 0V. The ORe5 controller's 24V terminal is connected to terminal 49 of only one (reference) TRN controller.

Safety

ORe5 controllers must be energized by a power supply which complies with safety rules of protection against electric shock - SELV circuit in accordance with the ČSN 2000-4-41 standard.

Disposal and Recycling

Controllers contain electronic parts and a plastic box. After exceeding its service life limit, the controllers belong to waste group Q14 according to the Waste Act (No.185/2001 Sb.) Regarding the possibility of parts recycling, the controllers belong to waste group R5 by course of the above-mentioned Waste Act.

Guarantee Terms and Conditions

Guarantee Terms and Conditions are provided in accordance with valid REMAK a.s. General Delivery, Payment and Guarantee Terms and Conditions. As standard, the manufacturer provides a guarantee period of 24 months from the goods delivery date. If extended guarantee conditions are fulfilled, an extended guarantee period of 5 years from the goods delivery date will be applied. The General Delivery, Payment and Guarantee Terms and Conditions are always printed on the rear side of the price list and invoice.